

# Link-S - Receiver, Magnet and Reed Switch Lighting Control

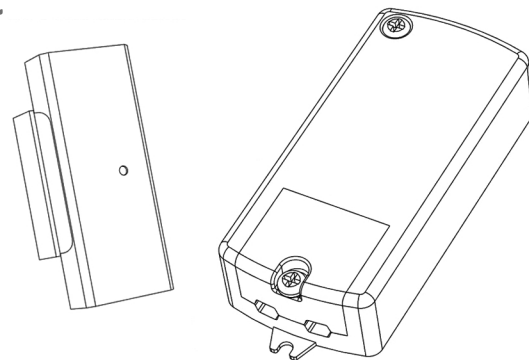

**Product Codes:**

SE79095 - Link-S - Receiver, Magnet and Reed Switch  
SE79195 - Link-S - Receiver  
SE79295 - Link-S - Magnet & Reed Switch

## INSTALLATION INSTRUCTIONS

**IMPORTANT:** Please read these instructions before commencing installation and retain for future reference.

### Components

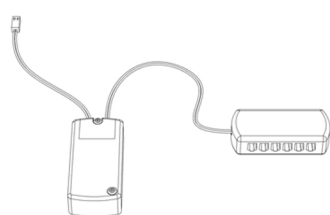

Receiver  
(SE79095 & SE79195 Only)

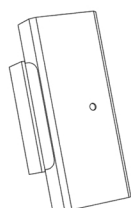

Magnet & Reed Switch  
(SE79095 & SE79295 Only)

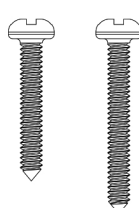

2 x Screws  
(SE79095 & SE79195 Only)

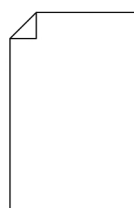

1 x Instructions  
Manual

### Tools Required



Screwdriver

### Important Safety Information

Please read these instructions carefully before attempting to install this product. It is advisable to keep these instructions in a safe place for future reference.

We recommend that you consult a qualified electrician. All electrical installation must be carried out in accordance with current IEE wiring regulations (BS7671).

These products must not be modified, if any modification are made, it may invalidate the warranty and may render the product unsafe. These LED lights operate low voltage (24V).

- Install on smooth flat surface(s) only.
- Do not exceed or stretch the cable length of each wire.
- This product is IP20 Rated.

### Technical Specification

Link-S – Magnet and Reed Switch	
Input Voltage	3V ( 2x 1632 button Batteries)
Standby Current	1.8uA
Transmitting Frequency	433.29Mhz
Transmitting Current	8mA
Range	>8m
Operating Temperature	-5°C to 40°C
Humidity	5% to 85% Non Condensing
Link-S - Receiver	
Input Voltage	24V
Max Power	72W
Range	>8m
Sensitivity	98dBm
Standby Power	≤0.15W
Operating Temperature	-5°C to 40°C
Humidity	5% to 85% Non Condensing

### Safety Instructions

1. This product is only suitable for connecting to Sensio LED lights and fittings.
2. Always read the installation guide of any product used in conjunction with this product.
3. Never exceed the total output of a LED driver or receiver.
4. Suitable for furniture lighting.
5. Class III safety extra low voltage (SELV).

**Waste Electrical & Electronic Equipment (WEEE)**

The symbol on the product, or on the document accompanying the product, the crossed out wheellie bin symbol, indicates that this product may not be treated as household waste. Instead it shall be handed over to the applicable collection point for the recycling of electrical and electronic waste.



UK Address: Sensio Ltd, Unit 7, Speedwell Road, Castleford, West Yorks, WF10 5PY  
EU Rep.: Sensio Lighting Dublin Ltd, The Black Church, St. Mary's Place, Dublin, Ireland, D07 P4AX

[www.sensio.co.uk](http://www.sensio.co.uk)

Technical drawings for illustration purposes only, Sensio has the right to change any information without prior notice.

**Installation**

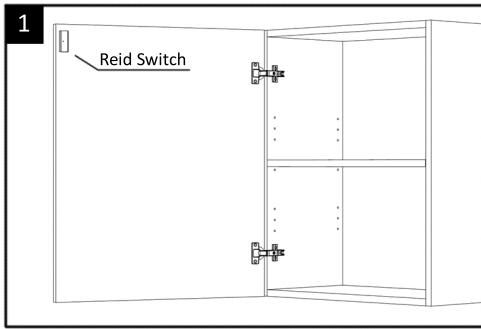

Peel the adhesive backing tape off of the Reid switch and stick it in your desired location.  
**Note:** The product is suitable for installation in many scenarios, please ensure that you measure and plan before installation.

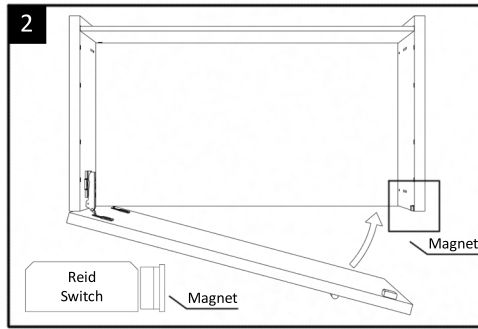

Peel the adhesive backing tape off of the magnet and stick it into a position where it will make contact with the Reid switch when the doors are closed. **Note:** The magnet can make contact with the side of the Reid switch.

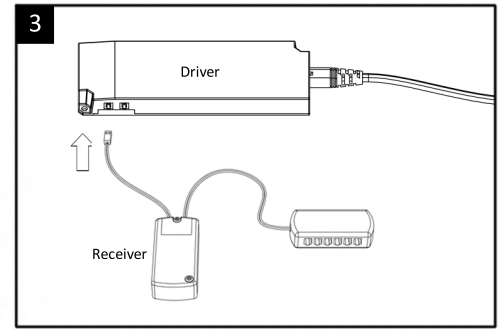

Connect the male-ended cable from the receiver into the LED Driver.

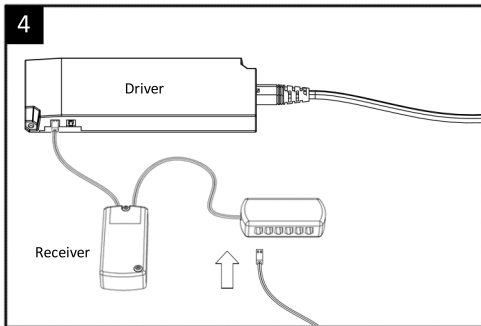

Connect your light to the receiver by inserting the male-ended JB4 cable into the female-end.

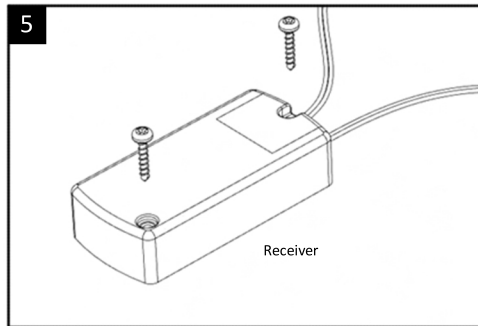

Secure the receiver in position using the screws included. Finally, connect the driver to the mains supply.

If you are installing a Sensio Wireless Magnetic Contact and Receiver with multiple Reid switches and magnets, simply follow stages 1 and 2 for installation. Once installed, each switch will trigger the lighting when the two components break contact.

**Operation**

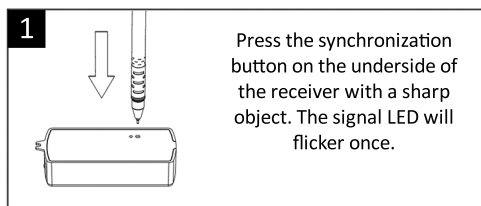

Press the synchronization button on the underside of the receiver with a sharp object. The signal LED will flicker once.

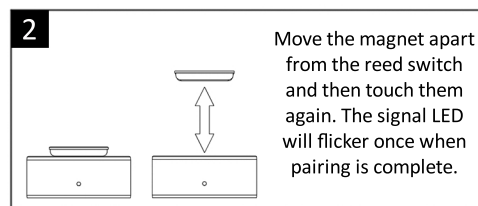

Move the magnet apart from the reed switch and then touch them again. The signal LED will flicker once when pairing is complete.

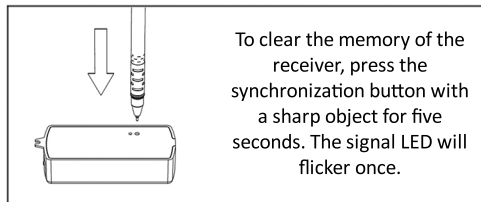

To clear the memory of the receiver, press the synchronization button with a sharp object for five seconds. The signal LED will flicker once.

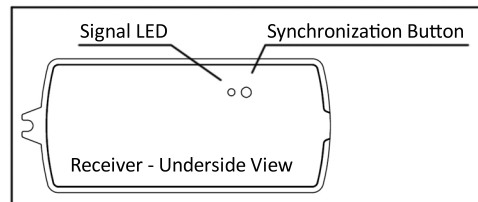

Each receiver can connect with up to five magnets and reed switches. The recommended scenario for this setup would be to have a magnet and reed switch on a series of cabinet doors. Opening each cabinet door would then trigger all the lights connected to the receiver. For example, a series of in-cabinet lights.

Each magnet and reed switch can connect with up to five different receivers. The recommended scenario for this setup would be to install the magnet and reed switch on the door to a room. Opening the door will then trigger all the lights connected to the receivers. For example, all of the lighting in that room.

**Maintenance & Care**

- Ensure that the power is disconnected prior to cleaning.
- To keep the finish of this product, wipe over with soft cloth periodically.
- Do not use harsh chemical solvents, this may dis-colour or damage the finish.
- Do not over-tighten screws on the terminal block.

UK Address: Sensio Ltd, Unit 7, Speedwell Road, Castleford, West Yorks, WF10 5PY  
EU Rep.: Sensio Lighting Dublin Ltd, The Black Church, St. Mary's Place, Dublin, Ireland, D07 P4AX

[www.sensio.co.uk](http://www.sensio.co.uk)

Technical drawings for illustration purposes only, Sensio has the right to change any information without prior notice.