



INSTALLATION
INSTRUCTIONS

CODE: SE20272C0

IMPORTANT: please read these instructions before commencing installation and retain for future reference.

Components

Tools required



1 x light



2 x Screws

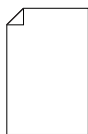

1 x Fitting Instructions



Pz1 Screw Bit



Power Drill

Important safety information

Please read these instructions carefully before attempting to install this product. It is advisable to keep these instructions in a safe place for further reference.

We recommend that you consult a qualified electrician. All electrical installations must be carried out in accordance with current IEE wiring regulations (BS7671).

These products must not be modified, if any modifications are made, it may invalidate the warranty and may render the product unsafe. These LED lights are powered by a rechargeable lithium-ion battery.

This product is for indoor use only. Keep out of moisture and use only in dry rooms.

Install on smooth flat surface(s) only.

Safety instructions

1. This product contains a rechargeable lithium-ion battery.
2. The light should be mounted onto a secure surface.
3. Position lights where they will not be exposed to steam or splashes etc.
4. Suitable for furniture lighting.
5. When the lamp expires the fitting must be replaced.

Waste Electrical & Electronic Equipment (WEEE)

The Symbol on the product, or on the document accompanying the product, the crossed out wheeie bin symbol, indicated that this product may not be treated as household waste. Instead it shall be handed over to the applicable collection point for the recycling of electrical and electronic waste.



Installation

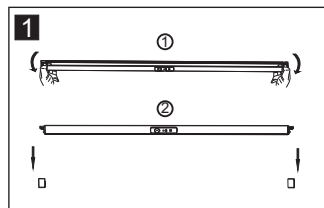

Take off the end covers.

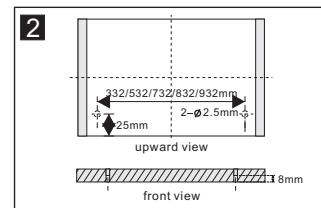

Drill the Ø 2.5mm hole.

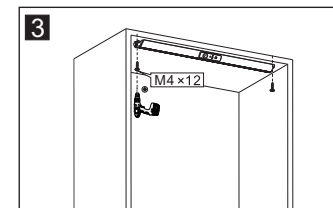

Fix the light.

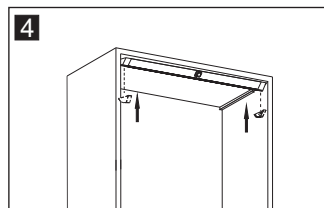

Fix the end covers.

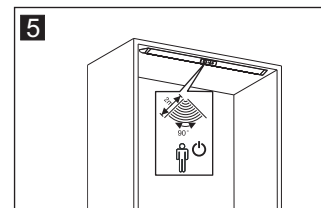

Complete chart.

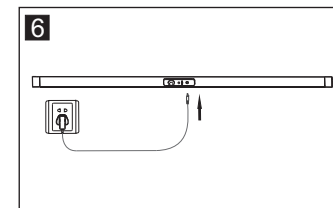

Charging instruction.

Operation

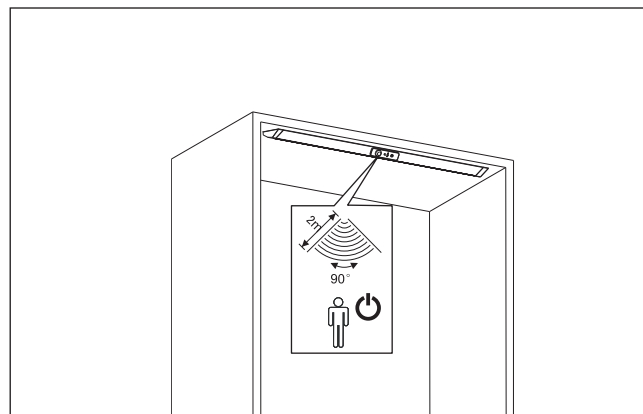

The Incline Wardrobe Light has a built-in PIR sensor switch. When the wardrobe door is opened this switch will detect motion from a distance of 2m and switch the light on. If motion is not detected for 30 seconds or more, the light will switch off.

Maintenance & Care

- Ensure that the power is disconnected prior to cleaning.
- To keep the finish of this product, wipe over with soft cloth periodically.
- Do not use harsh chemical solvents, it may dis-colour or damage the finish.

Unit 7 Speedwell Road, Whitwood, Castleford, West Yorkshire, WF10 5PY
www.sensio.co.uk

Technical drawings for illustration purposes only. Sensio has the right to change any information without prior notice. Make sure you check all hole cut outs before work commences.